



Danalock V3 BT HK Euro



Works with

Apple HomeKit

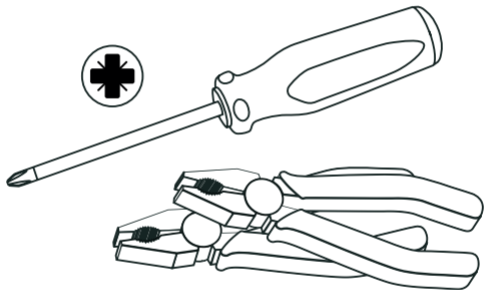

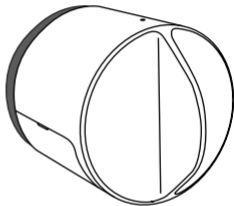



DCE3

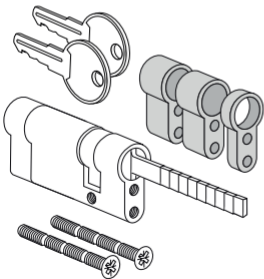

DCE4

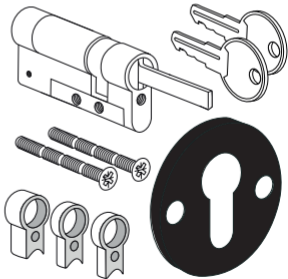

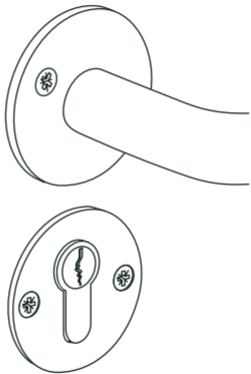
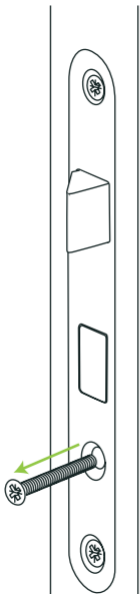

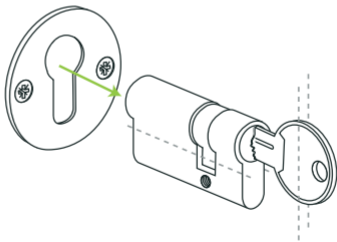
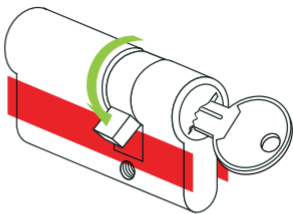
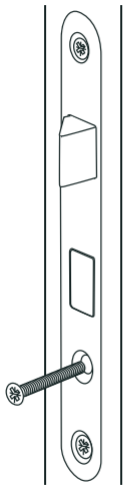

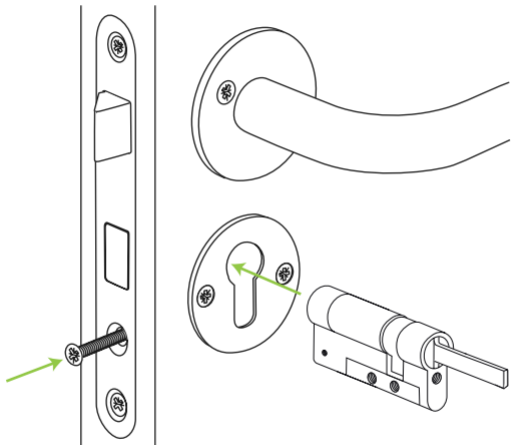



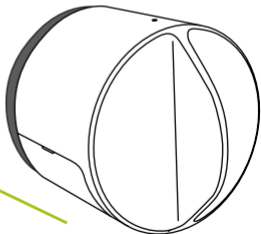
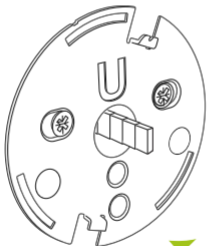
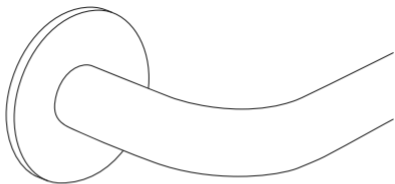
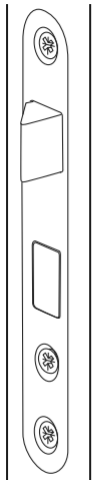

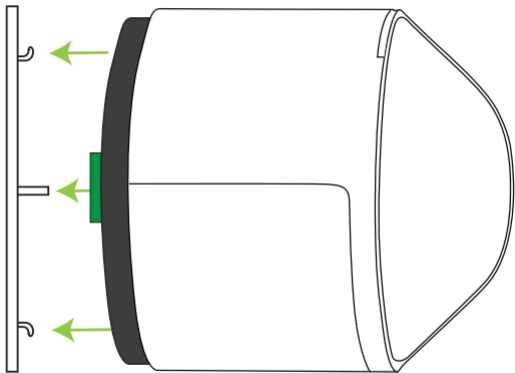

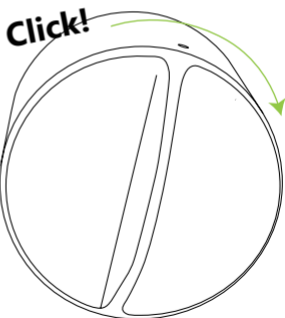
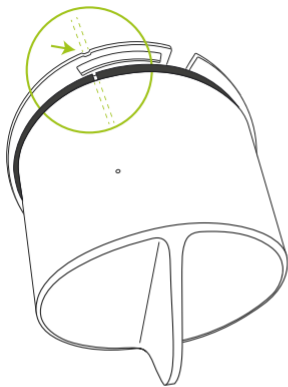

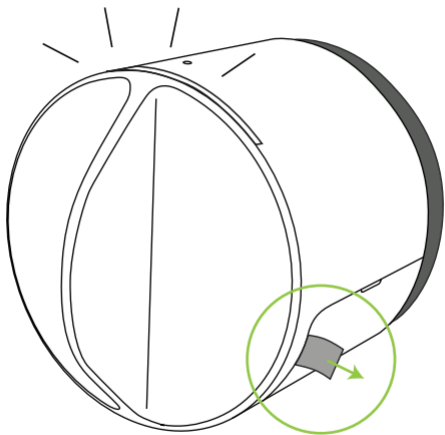

The following instructions are in english. Localized versions can be found with the QR-code below.



guide.danalock.com

Add the Danalock in the HomeKit App

When the Danalock has been mounted on the door it is ready to be set up with the Home app. Instructions on how to use the Home app can be found at:

<https://support.apple.com/en-us/HT204893>

The HomeKit setup code can be found both inside the battery compartment and on the "Simple Guidelines" leaflet.

Calibrate the lock

The Danalock needs to be calibrated in order to function properly. Calibration can be done either automatically or manually with the commands found on page 18.

The Danalock can be configured further with the commands found on page 18 to 19.

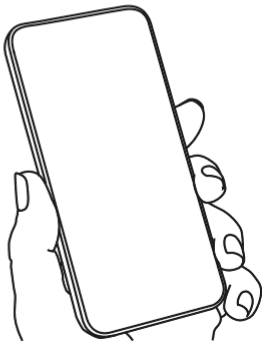



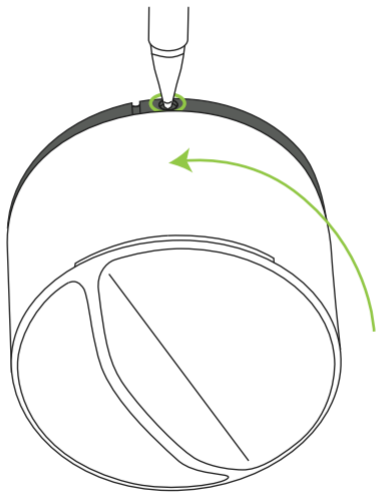

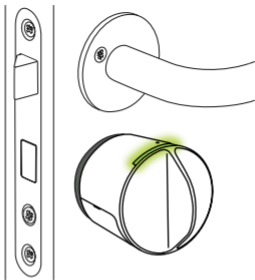

Dismounting



LED Signals



LED signal	LED color	Status indication
Long white blink		Power on. Batteries are activated
Constant red while performing		Device is locking
Constant green while performing		Device is unlocking
Red blink every 5 minutes		Device battery level is critically low
Constant red light		Device is ready to update
Blue while performing action		Device is updating

Configuring the Danalock V3 with click-commands

You can configure the Danalock via the button found in the small hole on the top of the lock. When you click through settings, the LED will change color according to the following scheme. When you get to the setting you want to change wait for 5 seconds and the Danalock will react to your command. This gives you plenty of time to navigate to the right command. If you make a wrong number of clicks, just stop at a number of clicks where the LED doesn't light up and wait for 5 seconds. The LED will flash red to indicate that it has timed out.

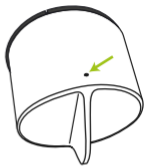

Manual click commands

Manual calibration Clicks: 2 LED: Yellow **Works on:** All

Turn the Danalock to the desired unlocked position. Start the calibration with the click command and wait for the LED to start blinking yellow. Turn the Danalock to the desired locked position while the LED blinks and click the button once to save the locked position.

Auto calibration Clicks: 3 LED: White **Works on:** All

Turn the Danalock to unlocked position and lift the handle if needed. Start the auto calibration with the click command. The Danalock will blink white while auto calibrating.

Hold back latch **Clicks:** 4 **LED:** Blue **Works on:** V3 HomeKit

Toggles between 3 hold back latch settings: Off, short wait and long wait. Every time this command is entered the setting will switch to the next option.

- Off will respond with a red blink when being set and will disable hold back latch.
- Short wait will respond with short green blinks when being set, and will hold the latch back for 5 sec.
- Long wait will respond with one long green blink when being set and will hold the latch back for 15 sec.

Auto lock timer **Clicks:** 5 **LED:** Purple **Works on:** V3 HomeKit

Toggles between 3 auto locking settings: Off, short wait and long wait. When this command is entered the setting will switch to the next option.

- Off will respond with a red blink when being set and will disable auto locking.
- Short wait will respond with short green blinks when being set. Will lock after 15 sec.
- Long wait will respond with one long green blink when being set. Will lock after 60 sec.

End to end unlock **Clicks:** 6 **LED:** Cyan **Works on:** V3 HomeKit

When this command is entered the setting will switch to the next option.

- Turning off will respond with one red blink when being set.
- Turning on will respond with one green blink when being set.

Twist assist **Clicks:** 8 **LED:** Blue/Green **Works on:** V3 HomeKit

When this command is entered the setting will switch to the next option.

- Turning off will respond with one red blink when being set.
- Turning on will respond with one green blink when being set.

Reset user settings **Clicks:** 10 **LED:** Red **Works on:** All

This action resets all user settings on the Danalock.
The Danalock responds by blinking red.

Firmware upgrade

To install the latest firmware on your Danalock download the Danalock app on App Store and log in as a "HomeKit only" user. Press the download icon on the front page in the app to start the firmware upgrade process.

Make sure to keep your phone near the Danalock during the entire firmware upgrade process.

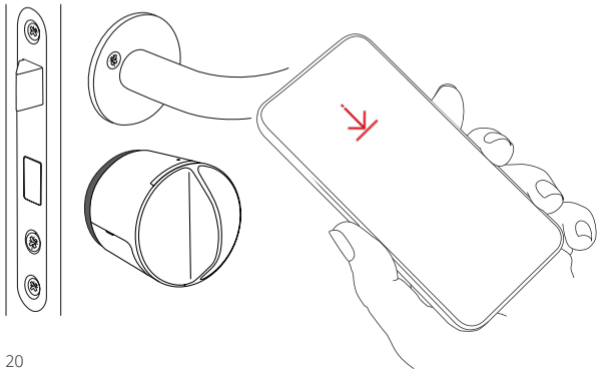

Technical information

Controlling this HomeKit-enabled accessory automatically and away from home requires an Apple TV with tvOS 10.0 or later or an iPad with iOS 9.0 or later set up as a home hub.

HomeKit technology provides advanced security with end-to-end encryption and authentication between a HomeKit-enabled accessory and your iPhone, iPad, or iPod touch.

HomeKit security communications are encrypted between a HomeKit-enabled accessory and your iPhone, iPad, or iPod touch.

Legal information

Use of the Works with Apple HomeKit logo means that an electronic accessory has been designed to connect specifically to iPod touch, iPhone, or iPad, respectively, and has been certified by the developer to meet Apple performance standards. Apple is not responsible for the operation of this device or its compliance with safety and regulatory standards. Apple, Apple Watch, iPad, iPad Air, iPhone, and iPod touch are trademarks of Apple Inc., registered in the U.S. and other countries. HomeKit is a trademark of Apple Inc.

Simple Guidelines

Please follow these guidelines when configuring, using or recycling the Danalock V3. Violating these guidelines may be dangerous, illegal or otherwise detrimental. Further detailed information is provided in this manual.

Terms of use

The Danalock V3 is designed for indoor use only. Use only Danalock approved accessories for the Danalock V3. Do not connect incompatible products, and do not operate the Danalock V3 where wireless radio communication is prohibited. Like hospitals, buildings near blasting sites etc.

Do Not Operate Where Prohibited

Do not allow the Danalock V3 unit to operate wherever wireless radio communication use is prohibited or when doing so may cause interference or danger as the Danalock V3 cannot be turned off after installation.

Device Operation and human exposure to electromagnetic fields

The Danalock V3 unit is a low power radio transmitter and receiver. Periodically the Danalock V3 wakes up either due to activity or by a timer. When it is ON, it receives and sends out radio frequency (RF) signals for a short period of time.

Specific Human Absorption Ratio (SAR)

The Danalock V3 unit is not intended for handheld use or to be worn on the body. A minimum separation of eight inches (8") (20 cm) is to be maintained between the Danalock V3 and any persons' body.

Pacemakers and other Medical Devices

If any other personal medical devices are used in the vicinity of a Danalock V3 unit, consult the manufacturers of the medical devices to determine if they are adequately shielded from external RF energy. Physicians may be able to assist in obtaining this information.

Interference

Like all wireless devices, the Danalock V3 may encounter electrical interference that may affect its performance. The Danalock V3 is tested and certified according to international and European standards. The performance hereof ensures

correct operation in the presence of electromagnetic interference and/or electrostatic discharge.

Category of use

The Danalock V3 is an electronic doorknob with wireless interface for mounting on access doors.

Security for electrical functions

The Danalock V3 has an indoor led indications for operational status but no sound alarms in case of a connected lock malfunction.

Security for electrical manipulation

The Danalock V3 is tested compliance to the EMC requirement laid out in the 2014/53/EU directive. The performance hereof ensures correct operation in the presence of electromagnetic interference and/or electrostatic discharge.

Children

The Danalock V3 series and its accessories are not used to solicit data from or market to children

Fire doors

The Danalock is not approved for use with fire doors.

Water-Resistance

The Danalock is not water-resistant. The lock must therefore be installed on the inside of the door where it is dry and not subjected to either water streams or submersion. EN 14846 corrosion resistance classification grade=0.

Accessories and Batteries

Use only approved accessories or batteries (intl model: CR17345). Only certified primary Lithium batteries cf. IEC / EN 60086-4: 2015 or IEC / EN 60086-4: 2019 shall be used in the product. Do not use rechargeable batteries. Go to <https://danalock.com/legal/lithium-batteries/> to find the list of approved batteries. Do not connect incompatible products. There is risk of explosion or fire if an incorrect type replacement battery contacts are shorted. Do not exceed the temperature ranges or other environmental conditions specified by the battery manufacturer. Dispose of used batteries according to the instructions provided with the batteries

Potentially Explosive Atmospheres

The Danalock cannot be turned off after installation, so any building installed with Danalock etc. must not be located in an area with a potentially explosive atmosphere and obey all signs and instructions not to use Danalock in such areas. Sparks in such areas could cause an explosion or fire resulting in bodily injury or even death.

Areas with a potentially explosive atmosphere are often, but not always marked clearly. Potential areas may include: fueling areas (such as gasoline stations); below deck on boats; fuel or chemical transfer or storage facilities; areas using liquefied petroleum gas (such as propane or butane); areas where the air contains chemicals or particles (such as grain, dust, or metal powders); and any other area where it would normally be advisable not to install the Danalock.

Battery Safety Information

Adhere to the following guidelines to avoid the risk of fire or explosion:

- 1 Dispose of the used battery according to the instructions provided with the battery.
- 2 Do not drop, puncture, disassemble, mutilate, or incinerate the battery.
- 3 Touching both terminals of a battery with a metal object will short circuit the battery. Do not carry batteries loosely if the contacts may touch coins, keys, and other metal objects (such as in pockets or bags).
- 4 Do not stack batteries taken out of the carry case.
- 5 Do not heat the batteries to try to rejuvenate their charge.
- 6 Do not exceed the temperature ranges or other environmental conditions specified by the battery manufacturer.
- 7 Never use the Danalock without the battery cover installed.
- 8 Do not mix batteries from different vendors.
- 9 Do not mix new and used batteries in the lock.

Disclaimer

It is very important to replace all 4 batteries at the same time. Please use only standard CR123 lithium batteries. Not replacing all batteries at the same time can affect the batteries to heat and potentially cause them to explode. Danalock has no responsibility in any way if the replacement of batteries is done inaccurately.



Disposal of Waste Batteries (Applicable in the European Union only)

The symbol (crossed out wheeled-bin) on your battery indicates that the battery shall not be disposed with other unsorted waste, but shall be collected separately and handed over to your local community waste collection point or other available collection points for the recycling, at the end of its use. If a chemical symbol is printed under the symbol it indicates that chemical substances (Hg = mercury, Cd = cadmium or Pb = lead) are contained in the battery.

Inappropriate waste handling could possibly have a negative effect on the environment and human health due to potential hazardous substances. With your cooperation in the correct disposal of this battery, you contribute to reuse, recycle and recover the batteries and our environment will be protected.

For more information, please contact the Government Waste-Disposal department in your country or the shop where the battery was purchased.

Disposal of Waste Electrical & Electronic Equipment of products for Household use (Applicable in the European Union only)

The symbol (crossed out wheeled-bin) on your product indicates that the product shall not be mixed or disposed with your household waste, at the end of its use. This product shall be handed over to your local community waste collection point for the recycling of the product.

For more information, please contact the Government Waste-Disposal department in your country.

Inappropriate waste handling could possibly have a negative effect on the environment and human health due to potential

hazardous substances. With your cooperation in the correct disposal of this product, you contribute to reuse, recycle and recover the product and our environment will be protected.

Disposal of Waste Electrical & Electronic Equipment of products for Household use

(Applicable in the European Union only)

For further information regarding the disposal of products for business purposes, please contact your dealer or distributor in your country. This product shall not be mixed or disposed with commercial waste.

Warranty

Danalock ApS products are covered by a limited manufacturer warranty. The Danalock ApS warranty is limited to the warranty rules and legislation present in each country. The warranty only covers manufacturing faults. The warranty does not cover misuse, wrong installation or damage due to a faulty installation or wrong maintenance. The invoice act as the proof of warranty, so please keep it as reference for any warranty complaints.

Qualified Service

Except for batteries, the Danalock V3 contains no user serviceable or replaceable parts. Non-functioning units must be returned to an authorized service center for repair or replacement.

Technical Assistance

If you have a problem and cannot find the information you need in the product documentation, please contact Danalock ApS at support@danalock.com. Please have the following information ready:

- 1 Serial number (preferred), MAC address or alias of the lock
- 2 Username used when registering / installing the lock
- 3 Username used when getting the error (if different username)
- 4 Time of incident

CE and UKCA mark

The Danalock V3 complies with the essential requirements of the RED directive 2014/53/EU and Radio Equipment Regulations 2017 – UK SI 2017 No. 1206 with respect to radio spectrum, EMC, Health and safety. EU Certificate and Declaration of conformity (DOC) can be downloaded from the homepage:

<https://danalock.com/legal/certificates/>

The Danalock V3 is assessed for electromechanically operated locks and striking plate's classification matrix compliance (N/A is equal to "Not applicable").



Listed from left to right:

- Category of use,
- Durability,
- Door mass and closing force,
- Suitability for use on fire/smoke doors,
- Safety,
- Corrosion Resistance,
- Security for physical attacks,
- Security – Electrical function,
- Security – Electrical manipulation. Detailed Safety Information

Danalock V3 BT

Product specifications

Supply Voltage	Via USB	4x3V DC (12V DC)
	Standby time on battery	450 Days
Temperature range	Active operating mode	-10°C to +40°C
	Storage	5°C to +50°C
Mechanical specifications	Dimensions (D x H)	59 mm x 59 mm
	Weight	130 g(excl bat) 195g (incl bat)
Material	Plastic	HB
Radio interfaces	Bluetooth LE	Max 4.7 dBm E.I.R.P.

US and Canada certification marks

This device contains radio transmitters that comply with CFR 47 Part 2.1091, Part 15.247 of the FCC rules and with RSS-GEN, RSS-102 and RSS-247 of Industry Canada requirements

Notice statements according to CFR 47 Part 15.19 / RSS-GEN:

The device complies with Part 15 of the FCC rules and with Industry Canada license exempt standard(s). Operation is subject to the following two conditions:

- 1 This device may not cause harmful interference, and
- 2 This device must accept any interference received, including interference that may cause undesired operation.

Déclarations selon le CFR 47 section 15.19 / RSS-GEN:

Le présent appareil est conforme aux CNR d'industrie Canada applicables aux appareils radio exempts de licence. L'exploitation est autorisée aux deux conditions suivantes:

- 1 *l'appareil ne doit pas produire de brouillage, et*
- 2 *l'utilisateur de l'appareil doit accepter tout brouillage radioélectrique subi, même si le brouillage est susceptible d'en compromettre le fonctionnement.*

NOTICE statements according to CFR 47 Part 15.21:

Changes or modifications made to this equipment not expressly approved by Danalock Aps may void the FCC authorization to operate this equipment.

Statements according to CFR 47 Part 2.1091 and RSS-102:

With respect to radiofrequency radiation exposure Information it is declared that this equipment complies with FCC radiation exposure limits set forth for an uncontrolled environment.

This equipment should be installed and operated with minimum distance of 20 cm between the radiator and your body. This transmitter must not be co-located or operating in conjunction with any other antenna or transmitter.

Déclarations selon le CFR 47 Sections 2.1091 et RSS-102:

Respectant les informations relatives à l'exposition aux radiations de fréquences radio, on déclare que cet équipement respecte les limites d'exposition aux radiations de la FCC aux conditions prévues pour un environnement non contrôlé.

Cet équipement doit être installé et fonctionner à une distance minimale de 20 cm entre l'appareil irradiant et votre corps.

Cet émetteur ne doit pas être installé ou utilisé en conjonction avec d'autres antennes ou d'autres émetteurs.

Japan

The product is approved in Japan with the certificate ID n°:

[R] 202-SMF017

This device is granted pursuant to the Japanese Radio Law (電波法)

＝当該機器には電波法に基づく、技術基準適合証明等を受けた特定無線設備を装着している

This device should not be modified (otherwise the granted designation number will become invalid)

本製品の改造は禁止されています。(適合証明番号などが無効となります。)

Regulatory labeling

The Danalock V3 BT product are regulatory compliant to the following regulation (Europe, USA/Canada, Japan, Australia/NZ):



FCC ID: 2AD5H-V3BT
IC:12588A-V3BT



202-SMF017

Apple legal notice

Use of the Works with Apple HomeKit logo means that an electronic accessory has been designed to connect specifically to iPod touch, iPhone, or iPad, respectively, and has been certified by the developer to meet Apple performance standards. Apple is not responsible for the operation of this device or its compliance with safety and regulatory standards.

Apple, Apple Watch, iPad, iPad Air, iPhone, and iPod touch are trademarks of Apple Inc., registered in the U.S. and other countries. HomeKit is a trademark of Apple Inc.

Danalock ApS

Gammel Stillingvej 427C
8462 Harlev, DK

+45 4242 8122
info@danalock.com

www.danalock.com